



**YOUR KEY TO AUTOMATION** ↔



# SW-03-S

AUTOMATIC SWING GATE OPENER  
USER MANUAL

**ALTECH AUTOGATE INT. PHILIPPINES INC.**  
B6 L28 Aphrodite St., Villa Olympia 6  
San Pedro, Laguna 4023

@Altech Autogate | @Altech Enterprise



☎ +63 917 870 9928  
+63 917 182 0156

☎ (02) 8398-5669

✉ autogate.ph@gmail.com

🌐 www.altech.ph





# NOTES

## I. Swing Gate Opener Features & Options:

1. **In case of power failure:** Use the manual override key to release the clutch to open or close the gate manually.
2. **When Gate is Obstructed:** Gate stops.
3. **Speed Control:** Gate opening and closing speed can be adjusted.
4. **Gentle Start:** The Gate Opener is equipped with a soft start function.
5. **Auto Close:** The Gate Opener System is equipped with Auto close function with adjustable closing time delay.
6. **Single or Dual Gate:** Either Single or Dual Swing Gate can be opened.
7. **Multiple Remote Transmitters:** The Controller can easily accommodate several unique extra remotes to control the swing gate opener
8. **Battery Back Up:** DC 24V back up battery can be incorporated
9. **Optional Devices:** DC 24 V Gate Lock, photocell, keypad, photocell, push button, large size or small size control box.
11. The Gate Opener can be configured to allow smooth noiseless operation.
12. The Gate Opener can be configured to enable open condition as default, or close condition as default depending on the placement of the provided hardware bracket brackets.

## II. Technical Specifications:

<b>Motor voltage:</b> 24VDC 60W	<b>Input power:</b> 220VAC± 10%, 50-60Hz
<b>Rotational speed:</b> 250RPM	<b>Peak thrust:</b> 3500N
<b>Arm's max travel:</b> 300 mm	<b>Nominal thrust:</b> 3000N
<b>Max single-leaf length:</b> 4meters	<b>Max single-leaf weight:</b> 500 KG
<b>Environment Temperature:</b> -25°C - +55°C	<b>Gear type:</b> Worm gear
<b>Max absorbed power:</b> 144W	<b>Nominal input power:</b> 2A

## III. Preparing The Installation Site:

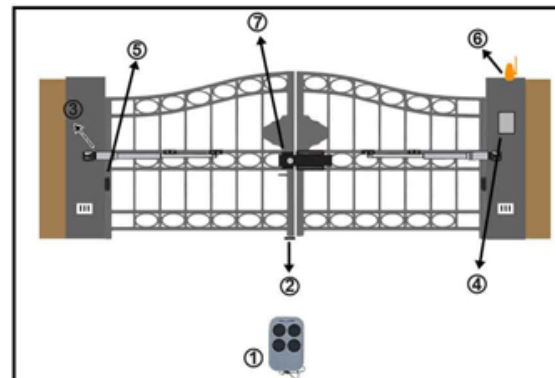

Figure 1

1. Remote Control
2. Rubber Stopper
3. Swing Gate Opener Motor
4. Control Box
5. Photocell Sensor (optional)
6. Flashing Light Alarm (optional)
7. Electronic Lock (optional)

## IV. Installation

### 4.1 Preparation for Motor Installation

The gate motor is not applicable to a gate which is inefficient or unsafe, neither to solve the defects due to incorrect installation nor poor maintenance.

Check the following items before going for installation:

- 1) Make sure the weight and dimension of the gate conform to the operation range of the gate motor. Don't use the gate motor if the gate specifications do not meet the requirements.
- 2) Make sure the gate structure conform to the criteria of automatic operation and force regulations.
- 3) Make sure there is no serious friction existing in the opening or closing travel of the gate leaves.
- 4) Make sure the gate is at horizontal level that the gate will not move aside at any position.
- 5) Make sure the gate can bear the impact of the motor torque when it is installed on any hole of the bracket which the surface is sufficiently sturdy.
- 6) Make sure the photo sensors are installed on flat surfaces to ensure the two ends of receiving and transmitting corresponded to each other.
- 7) Check the dimensions of the motors as below:

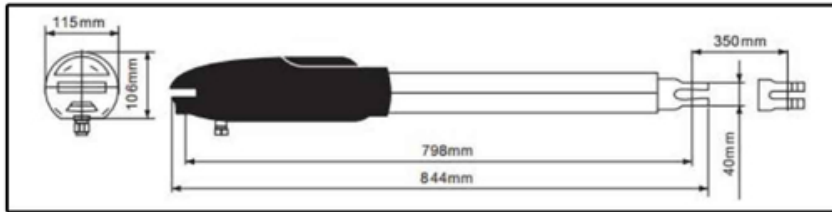

Figure 2

- 8) Make sure to leave enough space when the gate is opening.

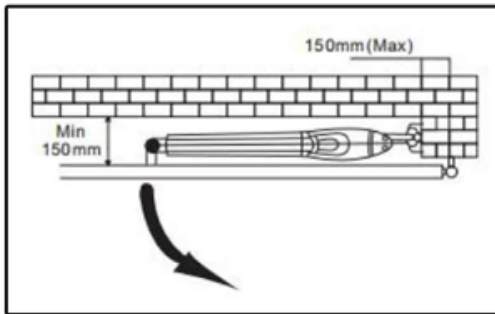

Figure 3

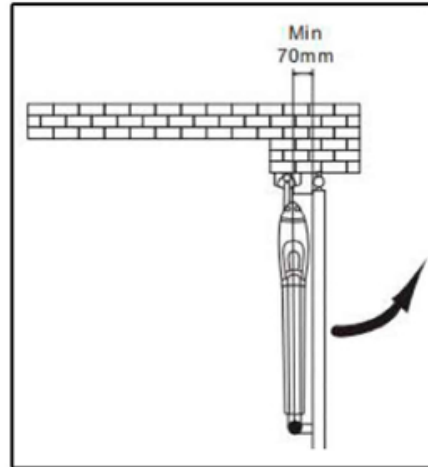

Figure 4

4.2 If the gate is OPENED OUTWARD, please leave at least 70mm between the post brackets and the gate.

## OPTIONAL ACCESSORIES FOR YOUR AUTOMATIC GATE

### FLASHING LIGHTS



AL-03  
FLASHING LIGHT

AL-04  
FLASHING LIGHT W/ BUZZER

AL-06  
FLASHING LIGHT W/ ANTENNA

### RECEIVERS



JS-092  
INDOOR RECEIVER

JS-084  
OUTDOOR RECEIVER

JS-093  
INDOOR EXTERNAL RECEIVER

SGC-01  
WIFI GATE RECEIVER CONTROLLER

### REMOTE CONTROLLERS



RC-12G  
REMOTE CONTROL

SM-24LT  
REMOTE CONTROL WITH CLIP

HPRC-10  
LONG DISTANCE RC TRANSMITTER

RC-12BG  
REMOTE CONTROL

RC-12C  
REMOTE CONTROL CLIP HOLDER

ST-03  
WIRELESS WALL MOUNTED TOUCH SWITCH

### SAFETY AND SECURITY



EL-01  
ELECTRONIC LOCK FOR SWING GATE

EL-04  
ELECTRONIC GROUND LOCK FOR SWING GATE

E-214  
ELECTRIC DOOR LOCK

WPC-01  
WIRELESS WATERPROOF KEYPAD

HW-06  
INFRARED PHOTOCCELL SENSOR



6. To set auto close time:

When digital display indicate P9, the gate opener is on auto close time setting. There is 0-99s for optional. 0s mean the gate opener would not auto close. Max auto close time is 99s. Each time you press and release the [INC-] button, the figure increase by 1; each time you press and release the [DEC-] button, the figure decrease by 1. Press the [FUN] button to store the data when the auto close time chosen, then the auto close time getting finished. (factory set 0)

7. To set lamp/alarm output control:

When digital display Indicate PA, the gate opener is on lamp/alarm output control setting. There is 0-3 for optional. "0" means the alarm on mono stability model and the lamp without voltage output after the gate total close 30s, other time with voltage output. "1" means the alarm on mono stability model and the lamp would only flash when gate running. "2" means the alarm on bi-stability model and the lamp without voltage output after the gate total close 30s, other time with voltage output. "3" means the alarm on bi-stability model and the lamp would only flash when gate running. Each time you press and release the [INC+] button, the figure increase by 1; each time you press and release the [DEC-] button, the figure decrease by 1. Press the [FUN] button to store the data when the auto close time chosen, then the amp/alarm output control setting finished. (factory set 0)

8. To set lock time:

When digital display indicate Pb, the gate opener is on lock time control setting. The lock control time means the time we could control the lock. There is 0-1 for optional. "0" means the lock control time is 0.5s, "1" means the lock control time is 5s. Each time you press and release the [INC+] button, the figure increase by 1; each time you press and release the [DEC-] button, the figure decrease by 1. Press the [FUN] button to store the data when the lock control time chosen, then the lock time setting finished. (factory set 0)

9. To choose single/double gate open:

When digital display indicate PC, the gate opener is on single/double gate open setting. There is 0-3 for optional. "0" means the gate could not open by remote, "1" means just can open one single gate, "2" means can just open two leaf gate, "3" means can open one single gate as well as two leaf gate. Each time you press and release the [INC+] button, the figure increase by 1; each time you press and release the [DEC-] button, the figure decrease by 1. Press the [FUN] button to store the data when the single/double gate open chosen, then the remote button setting finished. (factory set 3)

10. To reset:

When digital display indicate Pd. the gate opener is on rest setting. After enter Pd setting, press the [FUN] to store and will reset successfully.

4.3 Using the leaf-opening angle as criteria to make sure all criteria in Figure 6 can be met

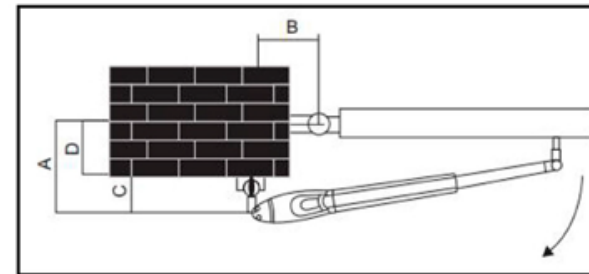

Figure 5

B(mm)	120	130	140	150	160	170	180	190
A(mm)								
120								
130								
140								
150								
160								
170								
180								
190								

Figure 6

- 1) "C" value is 139mm
  - 2) "D" can be measured from the gate easily
  - 3) "A" = "C" + "D"
  - 4) The value of "B" can be calculated from the value of "A" and the leaves opening angle. Ex. If "A" = 160mm with the leaves opening angle of 100 degrees, then the value of "B" is approximate 190mm
- NOTE: Please make sure "B" and "A" are similar or the same in value that the leaves can be operated smoothly. Also to reduce the burden of the motor.**

4.4 Installation of the Gear Motors

- 1) Choose the correct dimensions of the motors and position to be installed.
- 2) Check if the mounting surface the brackets to be installed is smooth, vertical and rigid.
- 3) Arrange the cable conduit for power supply cable of the motors.
- 4) In order to obtain the optimal supporting from the rear plate, please assemble two post brackets and one rear metal plast according to below photo
- 5) Loosen the two screws and remove the back cover of the motor as shown in photo
- 6) Place the leaves in the closed position.

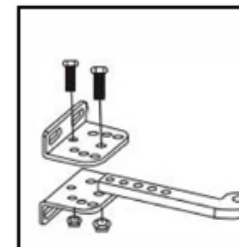

Figure 7

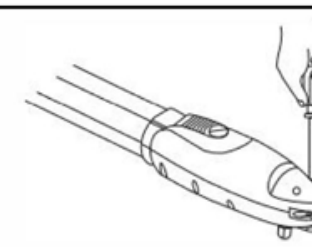

Figure 8

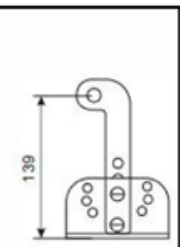

Figure 9

- 7) Refer to the distance of "B" in figure 6, place the rear plate in the correct position on the mounting surface. Inspect if the distance is proper as shown in Figure 6 i.e. the position the front plate of the motor to be installed.
- 8) Place two post brackets on the surface to be installed and mark the drilling points, then drill minimum diameter of 8mm holes by four on the mounting surface to be installed and fasten up the brackets with screws and washers
- 9) Please make sure the front plate is completely installed horizontally.

10) Refer to Figure 11, the distance between front plate of the motor and rear plated is 798mm, the difference in height is 22.5mm

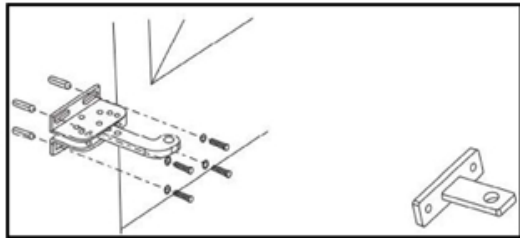

Figure 10

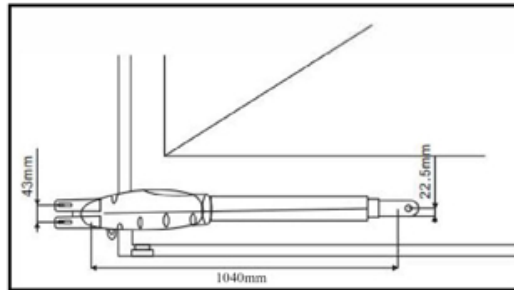

Figure 11

11) Clamp and fix the motor front plate on the door temporarily

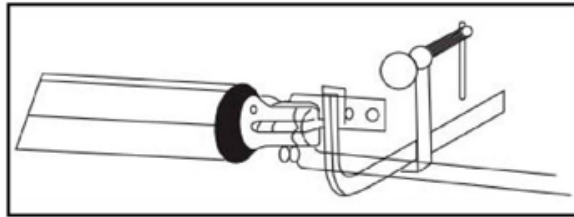

Figure 12

12) Lift up the motor and insert the screws into the front plate.

13) Open the gear motor cover and release the screws, then take out the bolt as below Figure 13.

Lift the motor overhead and push the gate to the end until the screw holes of the motor end matches the holes on the rear plate as shown in Figure 13.1 and fasten the motor to the rear plate with bolt and screw as shown in Figure 13.2

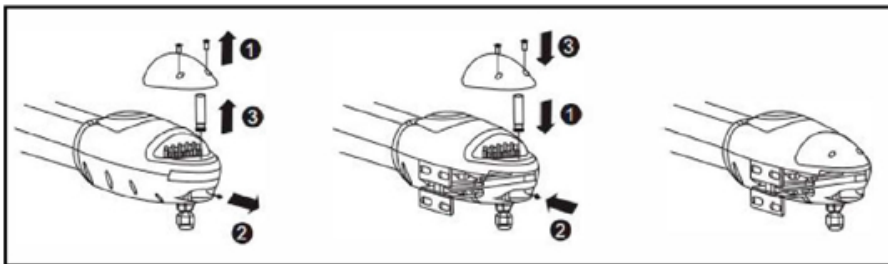

Figure 13

Figure 13.1

Figure 13.2

**CAUTION**

Adjusting the Force settings P1, P2, P3, and P4 to levels higher than the default setting may lead to adverse consequences. Setting the force too high can cause the motor to continue operating even at full opening or closing, posing a risk of damage to the gate opener.

1. Always check the light indicator on the Control Board after adjusting the Force settings.
2. If the motor's light indicator remains illuminated after adjustment, lower the Force settings to a more appropriate level to prevent potential damage to the motor.
3. Verify that the light indicator on the Control Board corresponds to the motor's status.

Failure to adjust the Force settings within the recommended range may result in motor malfunction or burnout, leading to costly repairs or replacements. Always exercise caution and follow the specified guidelines to ensure the safe and proper operation of the swing gate opener.

3. To set the high speed running time:

When digital display indicate P5, the gate opener is on high speed running time setting. There is 0-33s for optional. 0s means without high speed running, gate opener would keep running in slow speed. Max high speed running time 33s. Each time you press and release the [INC+] button, the figure increase by 1; each time you press and release the [DEC-] button, the figure decrease by 1. Press the [FUN] button to store the data when the high speed running time chosen, then the high speed running time setting finished. (factory set 5s)

4. To set the auto close time after swipe card:

When digital display indicate P6, the gate opener is on auto close time setting (NOTE: this auto close time just means the auto close function which realize through external device). There is 0-99s for optional. 0 means the gate opener would not auto close after swipe card. Max auto close time after swipe card 99s. Each time you press and release the [INC+] button, the figure increase by 1; each time you press and release the [DEC-] button, the figure decrease by 1. Press the [FUN] button to store the data when the auto close time after swipe card chosen, then the auto close time after swipe card finished. (factory set 10s)

5. To set the interval time:

5a. When digital display indicate P7, the gate opener is on open interval time setting. There is 0-10s for optional. 0s means double gates open simultaneously. "1" means the Motor 1 start to open 1 second before Motor 2 start to open. Max open interval time 10s. Each time you press and release the [INC+] button, the figure increase by 1; each time you press and release the [DEC-] button, the figure decrease by 1. Press the [FUN] button store the data when the open interval time chosen, then the open interval time setting finished. (factory set 0s)

5b. When digital display indicate P8, the gate opener is on close interval time setting. There is 0-10s for optional. 0s mean double gates close simultaneously. "1" means the Motor 2 start to close 1 second before Motor 1 start to close. Max close interval time 10s. Each time you press and release the [INC+] button, the figure increase by 1; each time you press and release the [DEC-] button, the figure decrease by 1. Press the [FUN] button to store the data when the close interval time chosen, then the close interval time setting finished. (factory set 0s)



Note: After you press LEARN button, if not receive the new remote signal within 5s indicator LED would turn on and exit learning.

Remove remote control:

Press and hold the LEARN button for about 5 second, if with one buzzer sound and indicator LED light on, then now means remove remote successfully.

#### Setting of the control board:

After power on, digital display will self-check from 00-99 with buzzer sound. If indicator LED light on, buzzer stop sound, it means the system is normal.

Basic operation method:

Press and hold the [FUN] button until the digital display shows P0. Now you enter the menu setting. You could through adjust the [INC+] [DEC-] to increase or decrease the serial number or numerical value. After data adjust well then press [FUN] to store the data. With one sound of buzzer, the store successfully. After store the data, the digital display would still on the menu number you just set, if you need to enter next menu setting, please press [INC+] or [DEC-] to choose and confirm with [FUN] to enter the menu number you want to set. Such as after you store the P0 value and press [FUN] to store it, then now the digital display would still show the number P0, and if you want go further to adjust P1, please press one [INC+], then digital display show P1, later press [FUN] to enter the P1 setting. And if you not need to enter next menu setting, you could press [LEARN] button to exit the menu setting.

#### 1. To set the soft start time:

When digital display indicate P0, the gate opener is on the soft start time getting. Tie soft start time adjustable from 0-6g, 0s means close the soft start time, max soft start time 6g. Each time you press and release the [INC+] button, the figure increase by 1; each time you press and release the [DEC-] button, the figure decrease by 1. Press the [FUN] button to store the data when the soft start time chosen, then the soft start time setting finished (Factory set 2s).

#### 2. To set the level of stall force:

2a. When digital display indicate P1, the gate opener is on Motor 1 low speed running stall force adjustment. There is 0-20 levels for optional, each time you press and release the [INC+] button, the figure increase by 1; each time you press and release the [DEC-] button, the figure decrease by 1. Press the [FUN] button to store the data when the stall force level chosen, then the stall force of Motor 1 low speed running stall force adjustment finished. (factory set 6 level)

2b. When digital display indicate P2, the gate opener is on Motor 1 high speed running stall force adjustment. There is 0-20 levels for optional. Each time you press and release the [INC+] button, the figure increase by 1; each time you press and release the [DEC-] button, the figure decrease by 1. Press the [FUN] button to store the data when the stall force level chosen, then the stall force of Motor 1 high speed running stall force adjustment finished. (factory set 10 level)

2c. When digital display indicate P3, the gate opener is on Motor 2 low speed running stall force adjustment. There is 0-20 levels for optional. Each time you press and release the [INC+] button, the figure increase by 1; each time you press and release the [DEC-] button, the figure decrease by 1. Press the [FUN] button to store the data when the stall force level chosen, then the stall force of Motor 2 low speed running stall force adjustment finished. (factory set 6 level)

2d. When digital display indicate P4, the gate opener is on Motor 2 high speed running stall force adjustment. There is 0-20 levels for optional. Each time you press and release the [INC+] button, the figure increase by 1; each time you press and release the [DEC-] button, the figure decrease by 1. Press the [FUN] button to store the data when the stall force level chosen, then the stall force of Motor 2 high speed running stall force adjustment finished. (factory set 10 level)

14) Fasten the nut tightly and loosen it for half round for motor supporting in rotating

15) Fasten the motor front end to the front plate with the bolt (A) and nut (B) tightly. Fully tighten the screw.

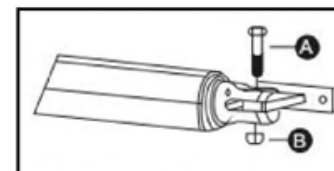

Figure 14

16) Connect the motor power cable as shown in Figure 15.

17) Close the gear motor cover by tightening the two screws as shown in Figure 16.

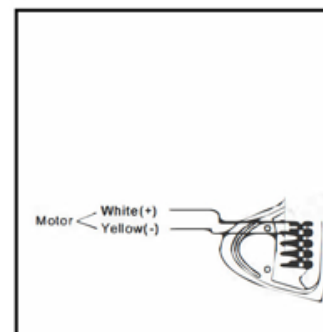

Figure 15

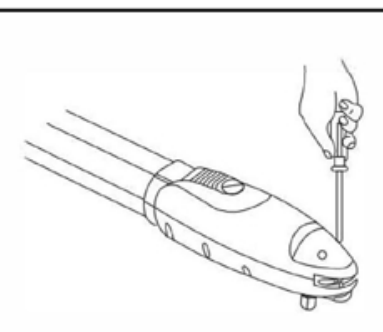

Figure 16

18) Gear Motor Release

A. Open the rubber cap. See Figure 17

B. Insert the override key and turn clockwise. See Figure 18

C. Pull up the clutch. See Figure 19

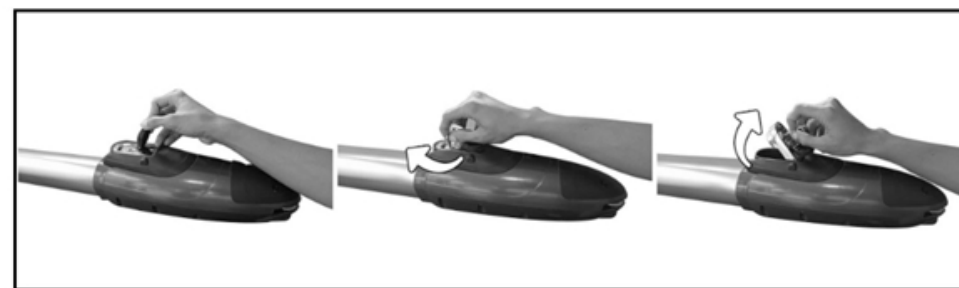
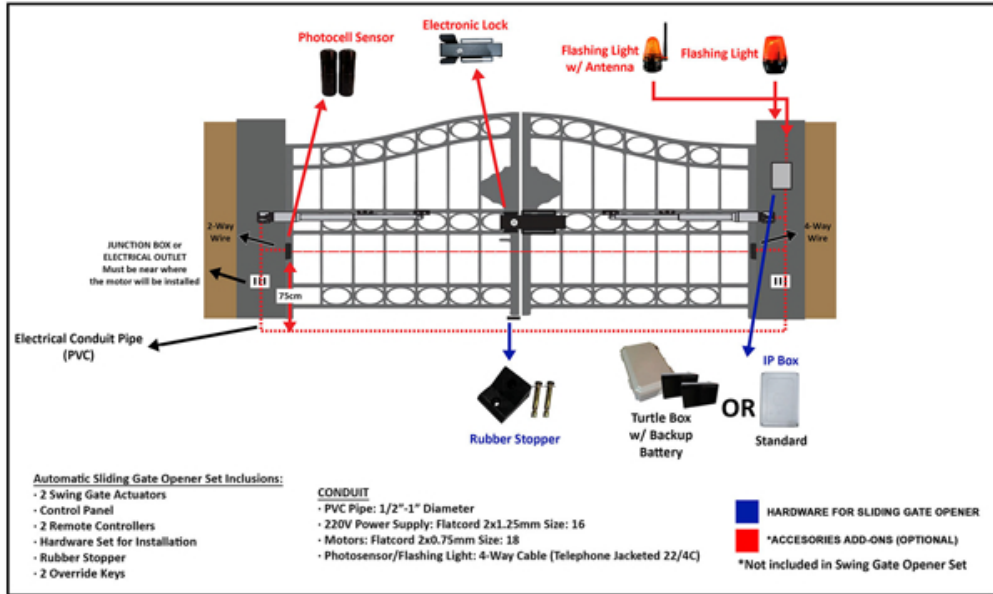

Figure 17

Figure 18

Figure 19

## Standard Electrical Swing Gate Opener Diagram



- 2 SIDE terminal is used for connecting any external device that operates double gate
- COM terminal is COMMON used for connecting the "ground" of external devices
- 1 SIDE terminal is used for connecting any external device that operates single gate
- Swipe Card terminal is used for connecting any external devices that will operate to open the gate
- COM terminal is COMMON used for connecting the "ground" of external devices
- Infrared terminal is used for connecting photo electric sensor
- 12V DC output is used for connecting photo electric sensor (Continuous output current <-200mA)
- 24V battery output is used for connecting the back up battery +
- 24V battery output is used for connecting the back up battery -
- 24V DC output is used for connecting external device. (such as photo electric sensor, max current output 1A)
- GND is used for connecting the "ground" of external devices
- 24V DC lamp output is used for connecting flash light
- 24V DC lamp output is used for connecting flash light -
- 24V DC lock output—the NF terminal which used for connecting the electric lock
- COM is COMMON used for connecting the "ground" of lock
- 24V DC lock output—the NA terminal which used for connecting the magnetic lock
- 24V DC alarm output
- 24V DC alarm output

- 19 and 20. Motor terminal is used for connecting the motor 1 installed on the gate that opens later and close first. This terminal connect 1st red wire (counted from your left hand side to right hand side)
  21. and 22. Motor2 Delay terminal is used for connecting the motor 2 installed on the gate that opens first and close later. Thig terminal connect 1st blue wire (counted from your left hand side to right hand side).
- NOTE: If for single gate, the gate motor just can connect the Motor 2 Delay terminal.

23. AC 24V input is used for connecting the transformer
24. AC 24V input is used for connecting the transformer
25. digital display is used for showing you the setting data
26. INC+ is used for figure increase when setting the data
27. FUN is used for storing the data
28. DEC- is used for figure decrease when setting the data
29. Learning button is used for program/remove remote

### Remote control

Button "1" depressed to operate single gate; button "2" depressed to operate double gate; button "3" depressed for alarm output

Program new remote control:

First step:

Press the LEARN button on the control board for about 1 second, the indicator LED would turn off, then now means have already enter learning

Second step:

Press any button of the new remote control for about 2 second, then digital display would show the remote number while indicator LED on board starts flash four times with one buzzer sound then now means the learning successfully.

## Configuration of Normally Closed Gate Opener System

