



**YOUR KEY TO AUTOMATION** 



# SW-02

AUTOMATIC SWING GATE OPENER  
USER MANUAL

**ALTECH AUTOGATE INT. PHILIPPINES INC.**  
B6 L28 Aphrodite St., Villa Olympia 6  
San Pedro, Laguna 4023

@Altech Autogate | @Altech Enterprise



 +63 917 870 9928  
+63 917 182 0156

 (02) 8398-5669

 autogate.ph@gmail.com

 [www.altech.ph](http://www.altech.ph)





# NOTES

## I. Product Configuration

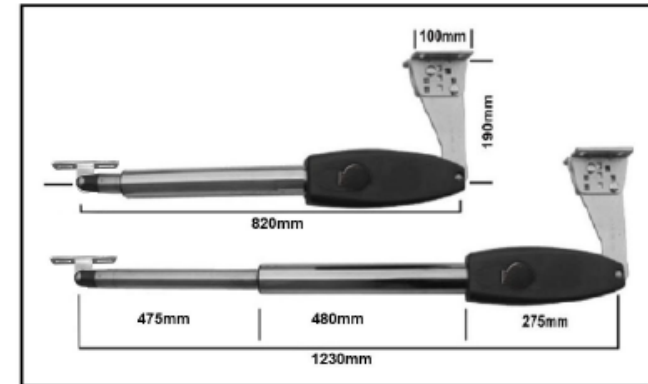

Figure 1

### **Nomenclature of Swing Gate Motor**

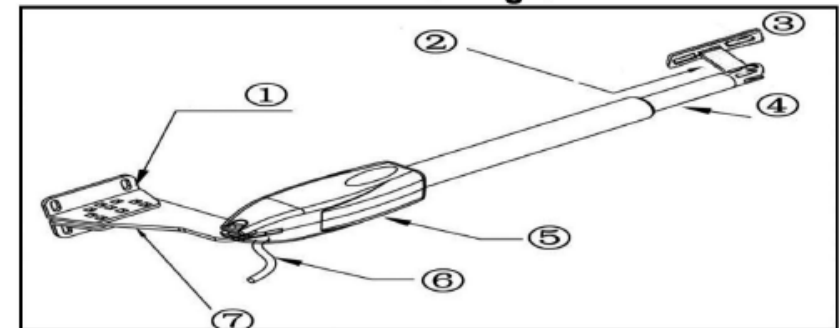

Figure 2

**Item 1:** Post Rear Fixed Bracket

**Item 2:** Extended Bracket Attached to Gate Structure

**Item 3:** Gate Front Fixed Bracket

**Item 4:** 300-400mm Extended Arm

**Item 5:** Motor Gear Box

**Item 6:** Power Cable

**Item 7:** Rear Bracket Fixed Plate Main Motor Arm

### **Override Manual Release Key**



Figure 3

## II. Swing Gate Opener Features & Options:

- In case of power failure:** Use the manual override key to release the clutch to open or close the gate manually.
- When Gate is Obstructed:** Gate stops.
- Speed Control:** Gate opening and closing speed can be adjusted.
- Gentle Start:** The Gate Opener is equipped with a soft start function.
- Auto Close:** The Gate Opener System is equipped with Auto close function with adjustable closing time delay.
- Single or Dual Gate:** Either Single or Dual Swing Gate can be opened.
- Multiple Remote Transmitters:** The Controller can easily accommodate several unique extra remotes to control the swing gate opener
- Battery Back Up:** DC 24V back up battery can be incorporated
- Optional Devices:** DC 24 V Gate Lock, photocell, keypad, photocell, push button, large size or small size control box.
- The Gate Opener can be configured to allow smooth noiseless operation.
- The Gate Opener can be configured to enable open condition as default, or close condition as default depending on the placement of the provided hardware bracket brackets.

## III. Technical Specifications:

Motor voltage: 24VDC 60W	Input power: 220VAC± 10%, 50-60Hz
Rotational speed: 300RPM	Arm's extended speed: 2.4 cm/s
Arm's max travel: 300 mm	Continue running time: 5 minutes
Max single-leaf length: 2.5meters	Max single-leaf weight: 350 KG
Environment Temperature: -25°C - +55°C	Protection Class: IP55
Max gate open angle: 110 degree	Dual Swing Gate Gross weight : 17.5kg

## IV. Preparing The Installation Site:

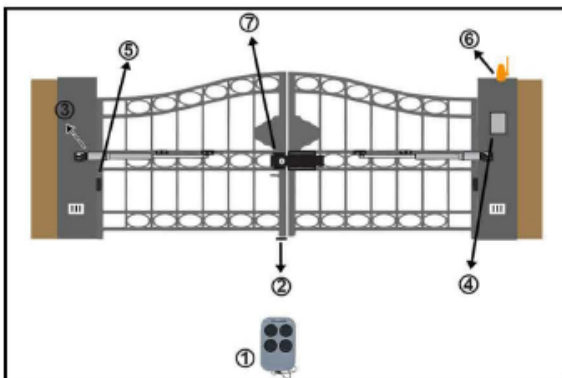

Figure 4

- Remote Control
- Rubber Stopper
- Swing Gate Opener Motor
- Control Box
- Photocell Sensor (optional)
- Flashing Light Alarm (optional)
- Electronic Lock (optional)

# OPTIONAL ACCESSORIES FOR YOUR AUTOMATIC GATE

### FLASHING LIGHTS

- AL-03 FLASHING LIGHT
- AL-04 FLASHING LIGHT W/ BUZZER
- AL-06 FLASHING LIGHT W/ ANTENNA

### RECEIVERS

- JS-092 INDOOR RECEIVER
- JS-084 OUTDOOR RECEIVER
- JS-093 INDOOR EXTERNAL RECEIVER
- SGC-01 WIFI GATE RECEIVER CONTROLLER

### REMOTE CONTROLLERS

- RC-12G REMOTE CONTROL
- SM-24LT REMOTE CONTROL WITH CLIP
- HPRC-10 LONG DISTANCE RC TRANSMITTER
- RC-12BG REMOTE CONTROL
- RC-12C REMOTE CONTROL CLIP HOLDER
- ST-03 WIRELESS WALL MOUNTED TOUCH SWITCH

### SAFETY AND SECURITY

- EL-01 ELECTRONIC LOCK FOR SWING GATE
- EL-04 ELECTRONIC GROUND LOCK FOR SWING GATE
- E-214 ELECTRIC DOOR LOCK
- WPC-01 WIRELESS WATERPROOF KEYPAD
- HW-06 INFRARED PHOTOCELL SENSOR

release the [INC-] button, the figure increase by 1; each time you press and release the [DEC-] button, the figure decrease by 1. Press the [FUN] button to store the data when the auto close time chosen, then the auto close time getting finished. (factory set 0)

**7. To set lamp/alarm output control:**

When digital display Indicate PA, the gate opener is on lamp/alarm output control setting. There is 0-3 for optional. "0" means the alarm on mono stability model and the lamp without voltage output after the gate total close 30s, other time with voltage output. "1" means the alarm on mono stability model and the lamp would only flash when gate running. "2" means the alarm on bi-stability model and the lamp without voltage output after the gate total close 30s, other time with voltage output. "3" means the alarm on bi-stability model and the lamp would only flash when gate running. Each time you press and release the [INC+] button, the figure increase by 1; each time you press and release the [DEC-] button, the figure decrease by 1. Press the [FUN] button to store the data when the auto close time chosen, then the amp/alarm output control setting finished. (factory set 0)

**8. To set lock time:**

When digital display indicate Pb, the gate opener is on lock time control setting. The lock control time means the time we could control the lock. There is 0-1 for optional. "0" means the lock control time is 0.5s, "1" means the lock control time is 5s. Each time you press and release the [INC+] button, the figure increase by 1; each time you press and release the [DEC-] button, the figure decrease by 1 Press the [FUN] button to store the data when the lock control time chosen, then the lock time setting finished. (factory set 0)

**9. To choose single/double gate open:**

When digital display indicate PC, the gate opener is on single/double gate open setting. There is 0-3 for optional. "0" means the gate could not open by remote, "1" means just can open one single gate, "2" means can just open two leaf gate, "3" means can open one single gate as well as two leaf gate. Each time you press and release the [INC+] button, the figure increase by 1; each time you press and release the [DEC-] button, the figure decrease by 1. Press the [FUN] button to store the data when the single/double gate open chosen, then the remote button setting finished. (factory set 3)

**10. To reset:**

When digital display indicate Pd. the gate opener is on rest setting. After enter Pd setting, press the [FUN] to store and will reset successfully.

**V. Rear Bracket Installation Alternatives to Gate Posts:**

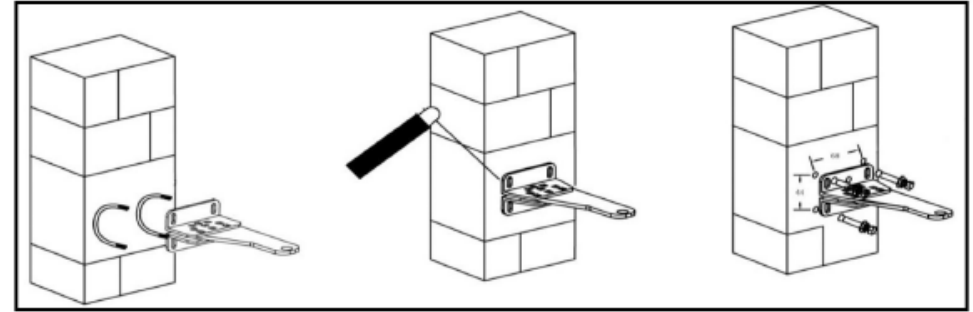

**Figure 5**

**1. Construction Drill and Bolts, Figure 5 right:**

- a. Drill 4 Holes of 8mm Diameter
- b. Insert the 4 Provided Concrete Bolts and Tighten Properly  
(Do not over tighten as you may strip the bolt out of the concrete or the brick)
- c. Place the Motor Connecting Bracket and Tighten with the Provided Screws

**2. Construction Drill and Weld, Figure 5 middle:**

- a. Drill 4 Holes of 8mm Diameter
- b. Locate the 4 Slotted Holes Post Bracket above the Drilled Holes
- c. Weld the Motor Bracket to the Post Bracket

**3. Precast U Bolts, Figure 5 left:**

- a. Locate the 4 Slotted Holes of the Post Bracket above the End of U Bolts
- b. Apply the Appropriate Screws
- c. Place the Motor Connecting Bracket and Tighten with the Provided Screws

**4. Adjusting different angles of Rear Bracket Fixed Plate to fit different Installing condition .**

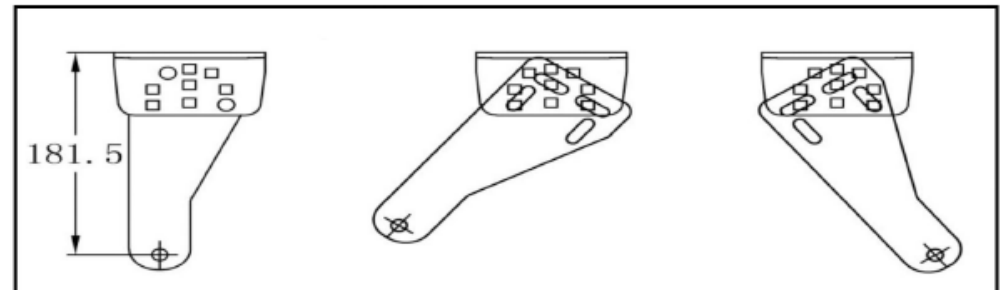

**Figure 6**

## VI. Install the Motor Fixed-End to the Gate Post-Bracket:

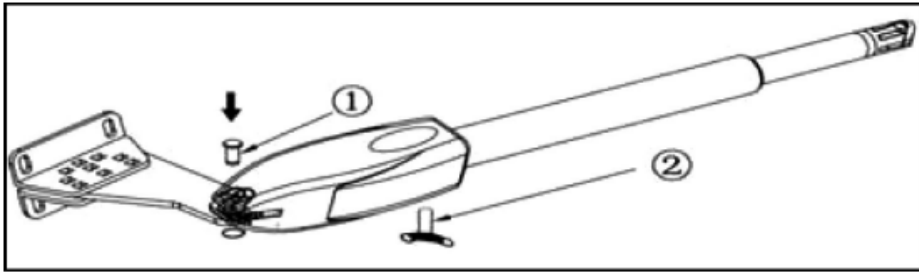

Figure 7

1. Ensure the Override Motor Key Post to face the ground away from the view of the public.
2. Once the Lock Pin and the Lock Washer are inserted between the Fixed End Motor and the Gate Post Bracket insure the power is not connected.
3. Insert Override Manual Key.
4. Turn the Key Clockwise to disengage the motor clutch to enable manual operation of gate.

## VII. Considerations:

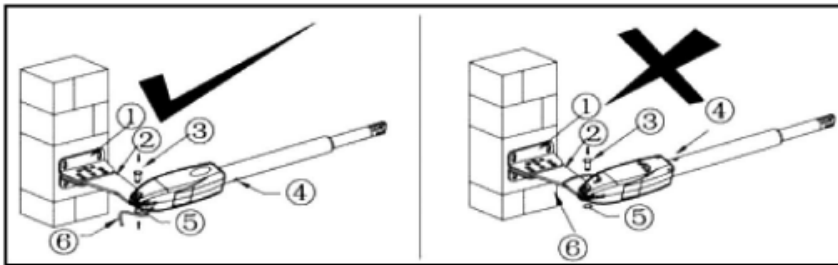

Figure 8

### Figure 8 left, Power Cable And Manual Override Release Placed Correctly

1. Post Rear Fixed Bracket
2. Rear Bracket Fixed Plate Main Motor Arm
3. Lock Pin

### Figure 8 right, Power Cable And Manual Override Release Placed Incorrectly

4. Rain Drainage Aperture
5. Washers and Lock Nuts
6. Power Cable

### Notice : Incorrect Installation, Figure 8 right:

Cable must not be installed above the motor arm. It may pinch and strip the cable and causes electric shock, Also the manual override release must be located face to the top. Follow correct installation as shown in Figure 8 left.

## ! CAUTION

Adjusting the Force settings P1, P2, P3, and P4 to levels higher than the default setting may lead to adverse consequences. Setting the force too high can cause the motor to continue operating even at full opening or closing, posing a risk of damage to the gate opener.

1. Always check the light indicator on the Control Board after adjusting the Force settings.
2. If the motor's light indicator remains illuminated after adjustment, lower the Force settings to a more appropriate level to prevent potential damage to the motor.
3. Verify that the light indicator on the Control Board corresponds to the motor's status.

Failure to adjust the Force settings within the recommended range may result in motor malfunction or burnout, leading to costly repairs or replacements. Always exercise caution and follow the specified guidelines to ensure the safe and proper operation of the swing gate opener.

### 3. To set the high speed running time:

When digital display indicate P5, the gate opener is on high speed running time setting. There is 0-33s for optional. 0s means without high speed running, gate opener would keep running in slow speed. Max high speed running time 33s. Each time you press and release the [INC+] button, the figure increase by 1; each time you press and release the [DEC-] button, the figure decrease by 1. Press the [FUN] button to store the data when the high speed running time chosen, then the high speed running time setting finished. (factory set 5s)

### 4. To set the auto close time after swipe card:

When digital display indicate P6, the gate opener is on auto close time setting (NOTE: this auto close time just means the auto close function which realize through external device). There is 0-99s for optional. 0 means the gate opener would not auto close after swipe card. Max auto close time after swipe card 99s. Each time you press and release the [INC+] button, the figure increase by 1; each time you press an release the [DEC-] button, the figure decrease by 1. Press the [FUN] button to store the data when the auto close time after swipe card chosen, then the auto close time after swipe card finished. (factory set 10s)

### 5. To set the interval time:

5a. When digital display indicate P7, the gate opener is on open interval time setting. There is 0-10s for optional. 0s means double gates open simultaneously. "1" means the Motor 1 start to open 1 second before Motor 2 start to open. Max open interval time 10s. Each time you press and release the [INC+] button, the figure increase by 1; each time you press and release [he [DEC-] button, the figure decrease by 1. Press the [FUN] button store the data when the open interval time chosen, then the open interval time setting finished. (factory set 0s)

5b. When digital display indicate P8, the gate opener is on close interval time setting. There is 0-10s for optional. 0s mean double gates close simultaneously. "1" means the Motor 2 start to close 1 second before Motor 1 start to close. Max close interval time 10s. Each time you press and release the [INC+] button, the figure increase by 1; each time you press and release the [DEC-] button, the figure decrease by 1. Press the [FUN] button to store the data when the close interval time chosen, then the close interval time setting finished. (factory set 0s)

### 6. To set auto close time:

When digital display indicate P9, the gate opener is on auto close time setting. There is 0-99s for optional. 0s mean the gate opener would not auto close. Max auto close time is 99s. Each time you press and

Note: After you press LEARN button, if not receive the new remote signal within 5s indicator LED would turn on and exit learning.

Remove remote control:

Press and hold the LEARN button for about 5 second, if with one buzzer sound and indicator LED light on, then now means remove remote successfully.

**Setting of the control board:**

After power on, digital display will self-check from 00-99 with buzzer sound. If indicator LED light on, buzzer stop sound, it means the system is normal.

**Basic operation method:**

Press and hold the [FUN] button until the digital display shows P0. Now you enter the menu setting. You could through adjust the [INC+] [DEC-] to increase or decrease the serial number or numerical value. After data adjust well then press [FUN] to store the data. With one sound of buzzer, the store successfully. After store the data, the digital display would still on the menu number you just set, if you need to enter next menu setting, please press [INC+] or [DEC-] to choose and confirm with [FUN] to enter the menu number you want to set. Such as after you store the P0 value and press [FUN] to store it, then now the digital display would still show the number P0, and if you want go further to adjust P1, please press one [INC+], then digital display show P1, later press [FUN] to enter the P1 setting. And if you not need to enter next menu setting, you could press [LEARN] button to exit the menu setting.

**1. To set the soft start time:**

When digital display indicate P0, the gate opener is on the soft start time getting. Tie soft start time adjustable from 0-6g, 0s means close the soft start time, max soft start time 6g. Each time you press and release the [INC+] button, the figure increase by 1; each time you press and release the [DEC-] button, the figure decrease by 1. Press the [FUN] button to store the data when the soft start time chosen, then the soft start time setting finished (Factory set 2s).

**2. To set the level of stall force:**

2a. When digital display indicate P1, the gate opener is on Motor 1 low speed running stall force adjustment. There is 0-20 levels for optional, each time you press and release the [INC+] button, the figure increase by 1; each time you press and release the [DEC-] button, the figure decrease by 1. Press the [FUN] button to store the data when the stall force level chosen, then the stall force of Motor 1 low speed running stall force adjustment finished. (factory set 6 level)

2b. When digital display indicate P2, the gate opener is on Motor 1 high speed running stall force adjustment. There is 0-20 levels for optional. Each time you press and release the [INC+] button, the figure increase by 1; each time you press and release the [DEC-] button, the figure decrease by 1. Press the [FUN] button to store the data when the stall force level chosen, then the stall force of Motor 1 high speed running stall force adjustment finished. (factory set 10 level)

2c. When digital display indicate P3, the gate opener is on Motor 2 low speed running stall force adjustment. There is 0-20 levels for optional. Each time you press and release the [INC+] button, the figure increase by 1; each time you press and release the [DEC-] button, the figure decrease by 1. Press the [FUN] button to store the data when the stall force level chosen, then the stall force of Motor 2 low speed running stall force adjustment finished. (factory set 6 level)

2d. When digital display indicate P4, the gate opener is on Motor 2 high speed running stall force adjustment. There is 0-20 levels for optional. Each time you press and release the [INC+] button, the figure increase by 1; each time you press and release the [DEC-] button, the figure decrease by 1. Press the [FUN] button to store the data when the stall force level chosen, then the stall force of Motor 2 high speed running stall force adjustment finished. (factory set 10 level)

**VIII. Installation of Extended/Retracted End Motor Arms to Gates:**

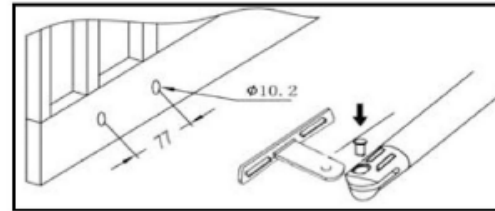

Figure 9

- A. Drill 2 Holes of 10.2mm Diameter With Space 77mm Between 2 Holes
- B. Locate the 2 Slotted Holes Gate Bracket above the Drilled Holes
- C. Place the End Motor Bracket to the Gate Bracket using the Appropriate Bolts and Tighten Properly (Please note these bolts used to fixed front bracket to the gate are not provided due to the thickness of each gate is different).
- D. Insert the Lock Pin and Clamping Washers

**Brackets Height:**

Ensure that the Post bracket height is in the same exact level with the gate bracket height. Failing to ensure accurate common heights will cause the motor arm to bend leading to failure. Also, the force to push or pull the gate will be reduced causing the motor to open or close the gates with difficulty or may not operate successfully at all, Severe different in height will damage the motor and the motor arm.

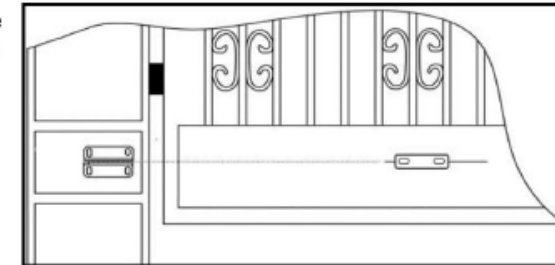

Figure 10

**Configuration of Normally Closed Gate Opener System**

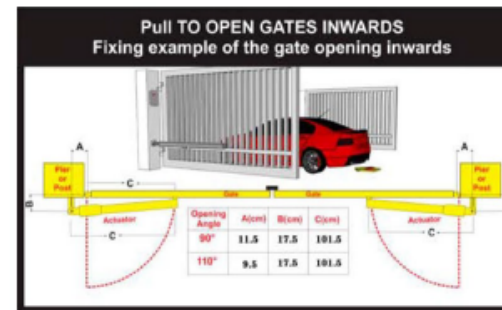

Figure 11

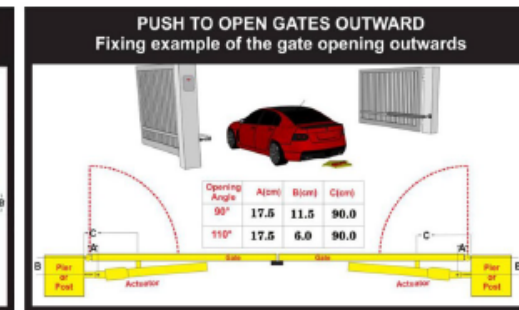
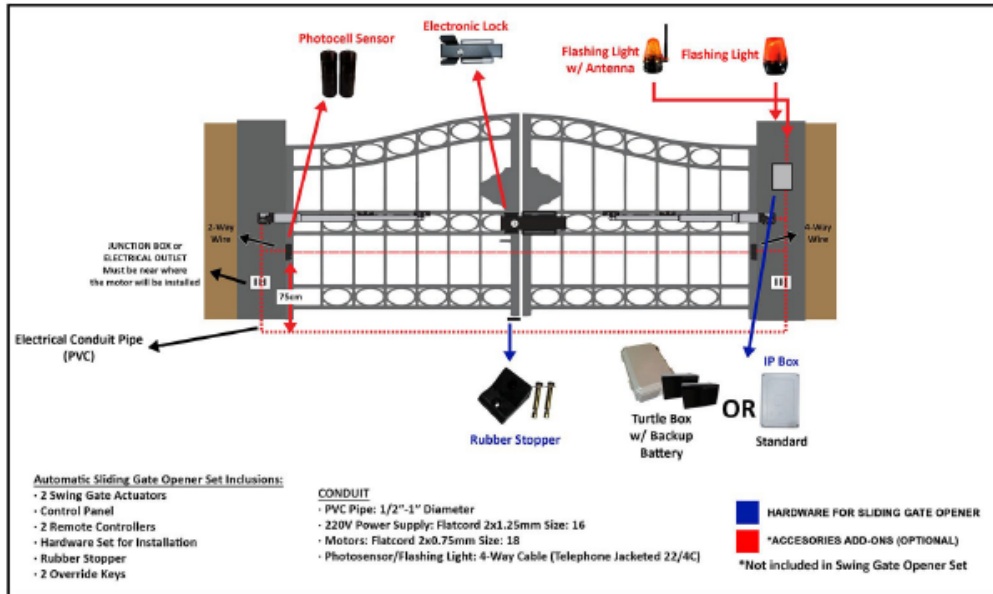

Figure 12

- A. The Distance between the Gate Post Edge and the Fixed Motor Hinge
- B. The Distance between the Gate Hinge and the Centerline of the Motor Hinge
- C. The Distance between the Gate Hinge and the Maximum Distance of the Retracted Motor Condition.

## Standard Electrical Swing Gate Opener Diagram



1. 2 SIDE terminal is used for connecting any external device that operates double gate
2. COM terminal is COMMON used for connecting the "ground" of external devices
3. 1 SIDE terminal is used for connecting any external device that operates single gate
4. Swipe Card terminal is used for connecting any external devices that will operate to open the gate
5. COM terminal is COMMON used for connecting the "ground" of external devices
6. Infrared terminal is used for connecting photo electric sensor
7. 12V DC output is used for connecting photo electric sensor (Continuous output current <-200mA)
8. 24V battery output is used for connecting the back up battery +
9. 24V battery output is used for connecting the back up battery -
10. 24V DC output is used for connecting external device. (such as photo electric sensor, max current output 1A)
11. GND is used for connecting the "ground" of external devices
12. 24V DC lamp output is used for connecting flash light
13. 24V DC lamp output is used for connecting flash light -.
14. 24V DC lock output—the NF terminal which used for connecting the electric lock
15. COM is COMMON used for connecting the "ground" of lock
16. 24V DC lock output—the NA terminal which used for connecting the magnetic lock
17. 24V DC alarm output
18. 24V DC alarm output

- 19 and 20. Motor terminal is used for connecting the motor 1 installed on the gate that opens later and close first. This terminal connect 1st red wire (counted from your left hand side to right hand side)
21. and 22. Motor2 Delay terminal is used for connecting the motor 2 installed on the gate that opens first and close later. Thig terminal connect 1st blue wire (counted from your left hand side to right hand side).

NOTE: If for single gate, the gate motor just can connect the Motor 2 Delay terminal.

23. AC 24V input is used for connecting the transformer
24. AC 24V input is used for connecting the transformer
25. digital display is used for showing you the setting data
26. INC+ is used for figure increase when setting the data
27. FUN is used for storing the data
28. DEC- is used for figure decrease when setting the data
29. Learning button is used for program/remove remote

### Remote control

Button "1" depressed to operate single gate; button "2" depressed to operate double gate; button "3" depressed for alarm output

Program new remote control:

First step:

Press the LEARN button on the control board for about 1 second, the indicator LED would turn off, then now means have already enter learning

Second step:

Press any button of the new remote control for about 2 second, then digital display would show the remote number while indicator LED on board starts flash four times with one buzzer sound then now means the learning successfully.

## Configuration of Normally Closed Gate Opener System

